

ASSEMBLY INSTRUCTION

TOMPKINS COFFEE TABLE ROUND Ø60

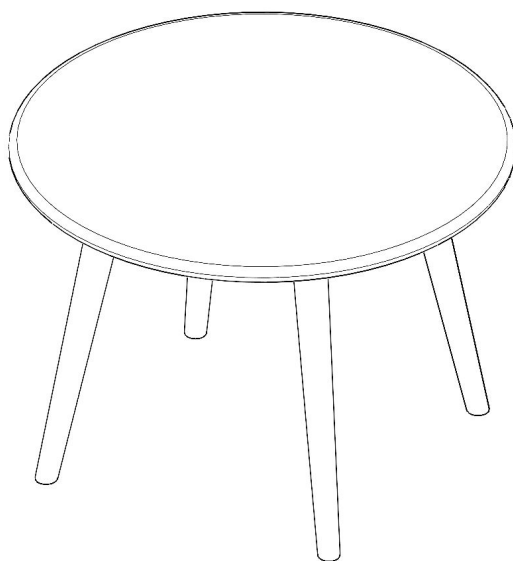

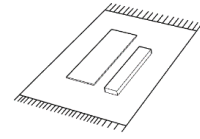
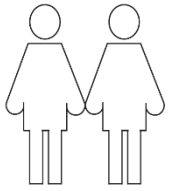

ROWICO

H O M E



List of part		
	Description	N.o of pcs
A	Bordstopp/Table top	1
B	Bordsben/Table legs	4

List of hardware		
	Description	N.o of pcs
a	 Hex bolt M8x30	4
b	 Washer Ø16/ Ø9	4
c	 Allen key N.o 6	1

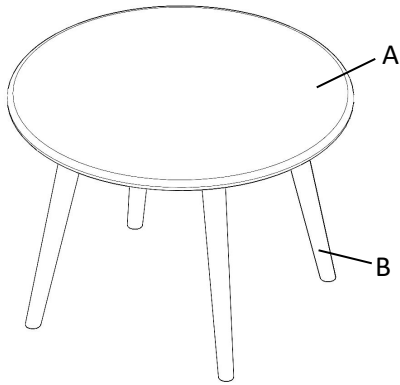

Step 1

