

47640200 47642930

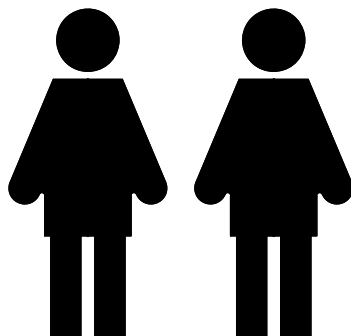
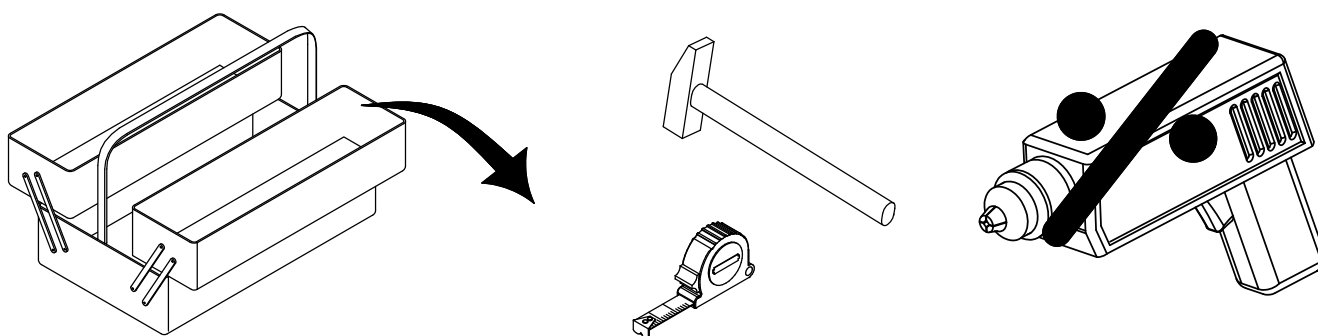
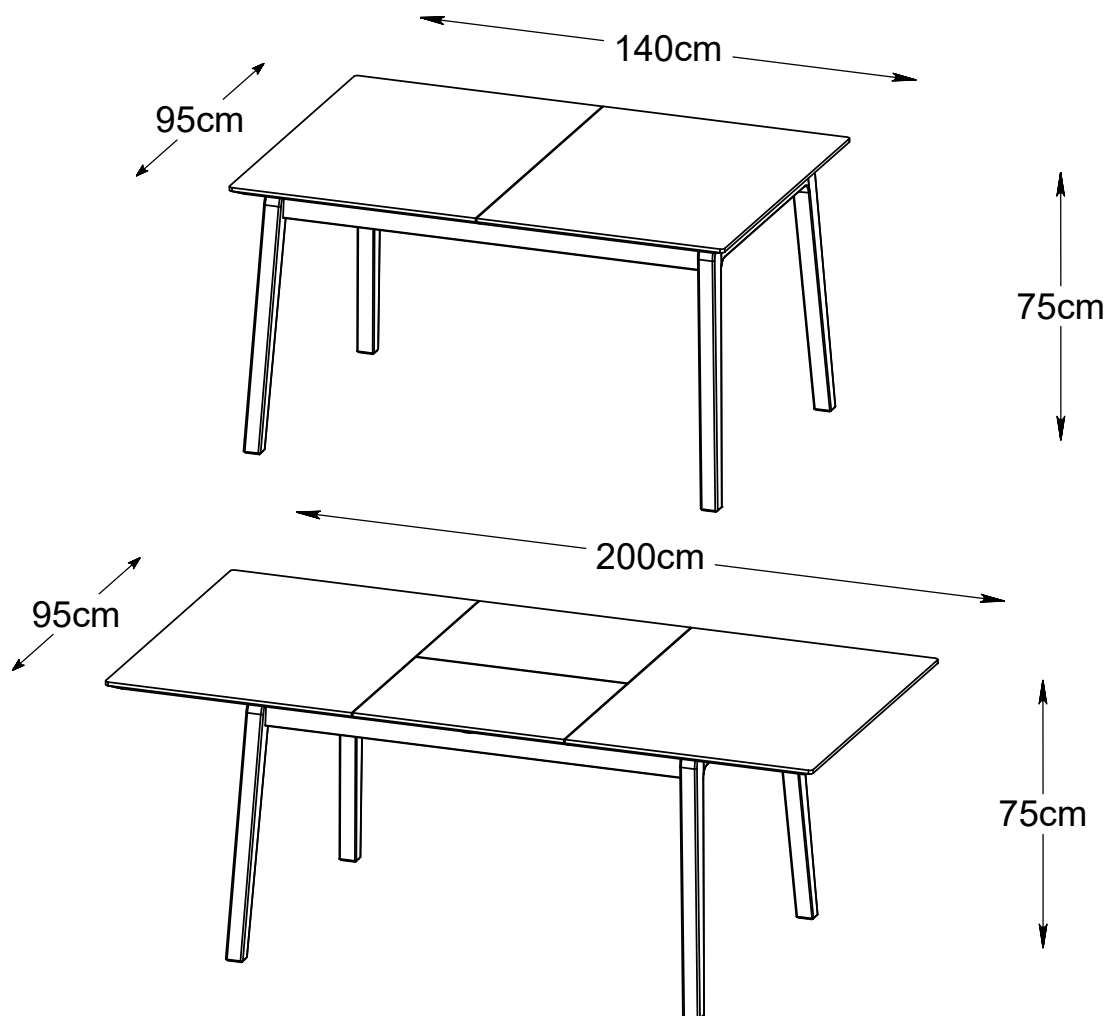

WICHTIG - FÜR SPÄTERE VERWENDUNG
AUFBEWAHREN - SORGFÄLTIG LESEN

AVIS - Ces instructions doivent être sauvegardées
Pour utilisation future - Les instructions doivent
être suivies

IMPORTANTE, conservar estas instrucciones
para futuro uso. Siga estas instrucciones atentamente

VIGTIGT - Samvejledningen skal opbevares
i arkiv til senere brug - Skal gennemlæses nøje

NOTICE - These instructions must be saved
for future use - Instructions must be followed

TEILCHECKLISTE
 LISTE DE CONTROLE
 LISTADO DE CONTROL
 TJEKLISTE
 CHECK LIST
47650200

Réf./No.	Réf./Art.	Qty./Stck./Quantité	Size / Maß / Dimension (mm)	Qty./Stck./Quantité	✓
1		1	1400(2000)x950x110		
2	32959602	2	890x725x48		



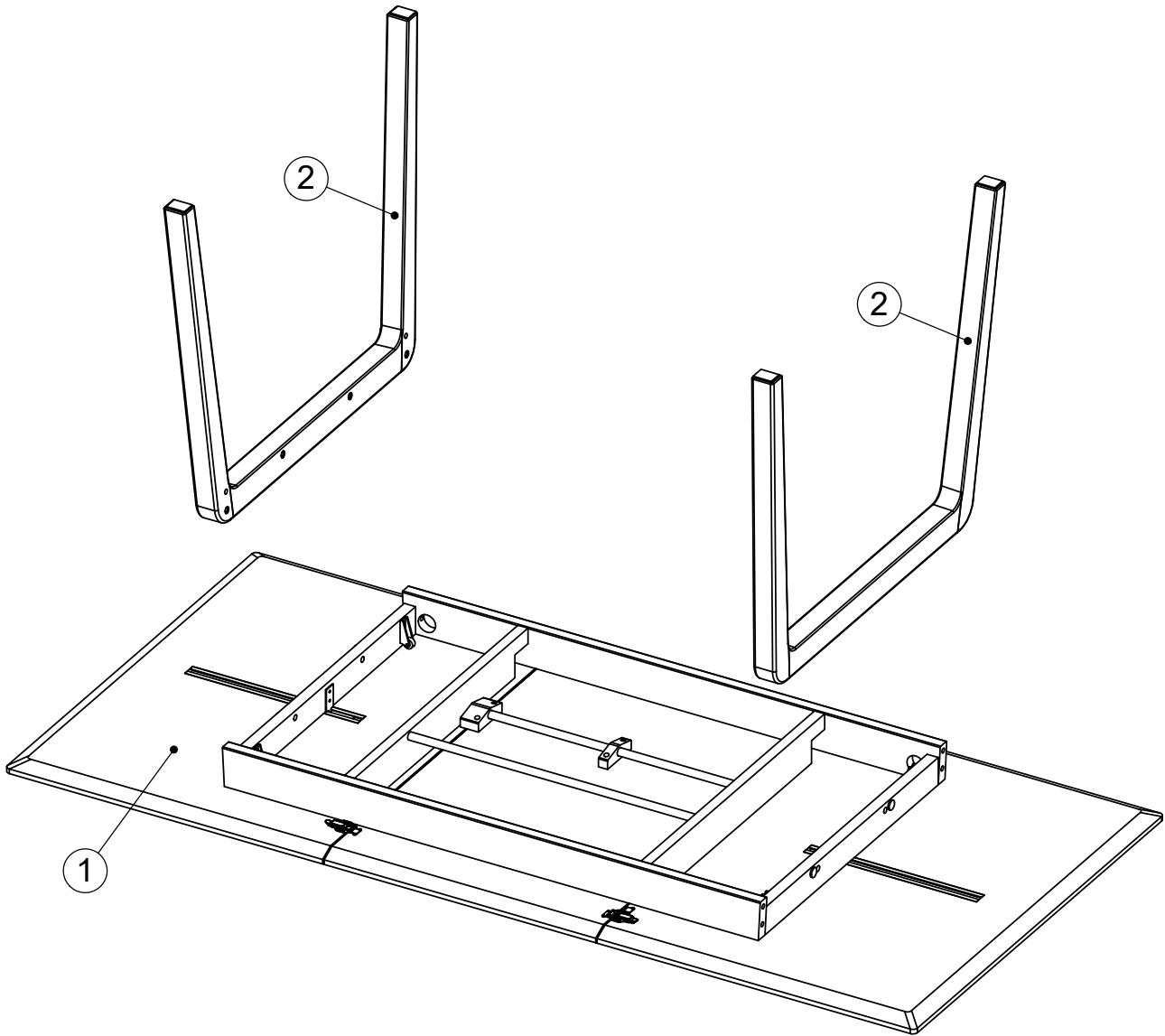

47652930

Réf./No.	Réf./Art.	Qty./Stck./Quantité	Size / Maß / Dimension (mm)	Qty./Stck./Quantité	✓
1		1	1400(2000)x950x110		
2	329596293	2	890x725x48		

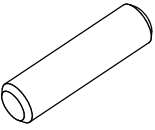
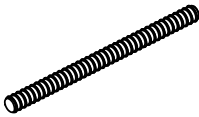
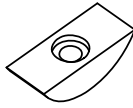

TEILCHECKLISTE - LISTE DE CONTROLE - LISTADO DE CONTROL- TJEKLISTE - CHECK LIST

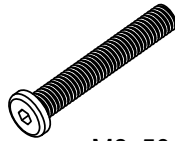
Réf./No.	Réf./Art.	Qty./Stck./Quantité	✓
A	229597	4	
B	229597	4	
C	229597	4	
D	229597	4	
E	229597	4	
F	229597	4	
G	229597	4	
H	229597	1	
J	229597	1	
K	229597	4	

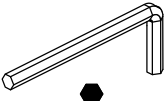
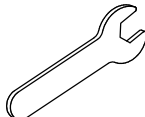
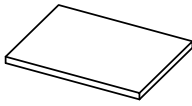
<p>4 - A</p>  <p>∅ 10 x 40 mm</p>	<p>4 - B</p>  <p>M8 x80 mm</p>	<p>4 - C</p> 	<p>4 - D</p>  <p>M8x12mm</p>	<p>4 - E</p>  <p>M8x50mm</p>	<p>4 - F</p>  <p>∅ 8 mm</p>
<p>4 - G</p>  <p>∅9x∅22 mm</p>	<p>1 - H</p>  <p>5 mm</p>	<p>1 - J</p>  <p>12mm</p>	<p>4 - K</p>  <p>40x30x3mm</p>		

Geehrter Kunde.
Hier haben Sie die Möglichkeit die mitgelieferten
Schrauben nachzumessen.

Cher Client.
La règle ci jointe vous permet de mesurer la visserie.

Estimado cliente.
aquí podrá medir la tornillería adjunta.

Kære kunde.
Her har De muligheden for at måle medsendte beslag.

Dear Customer.
Below you have the opportunity to measure the
Enclosed Hardware.

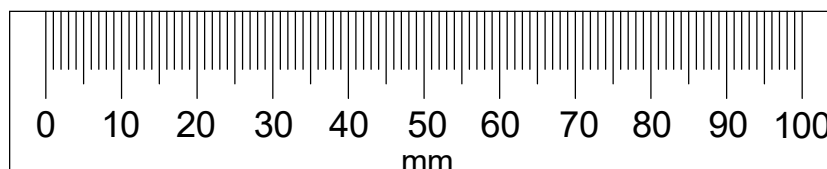

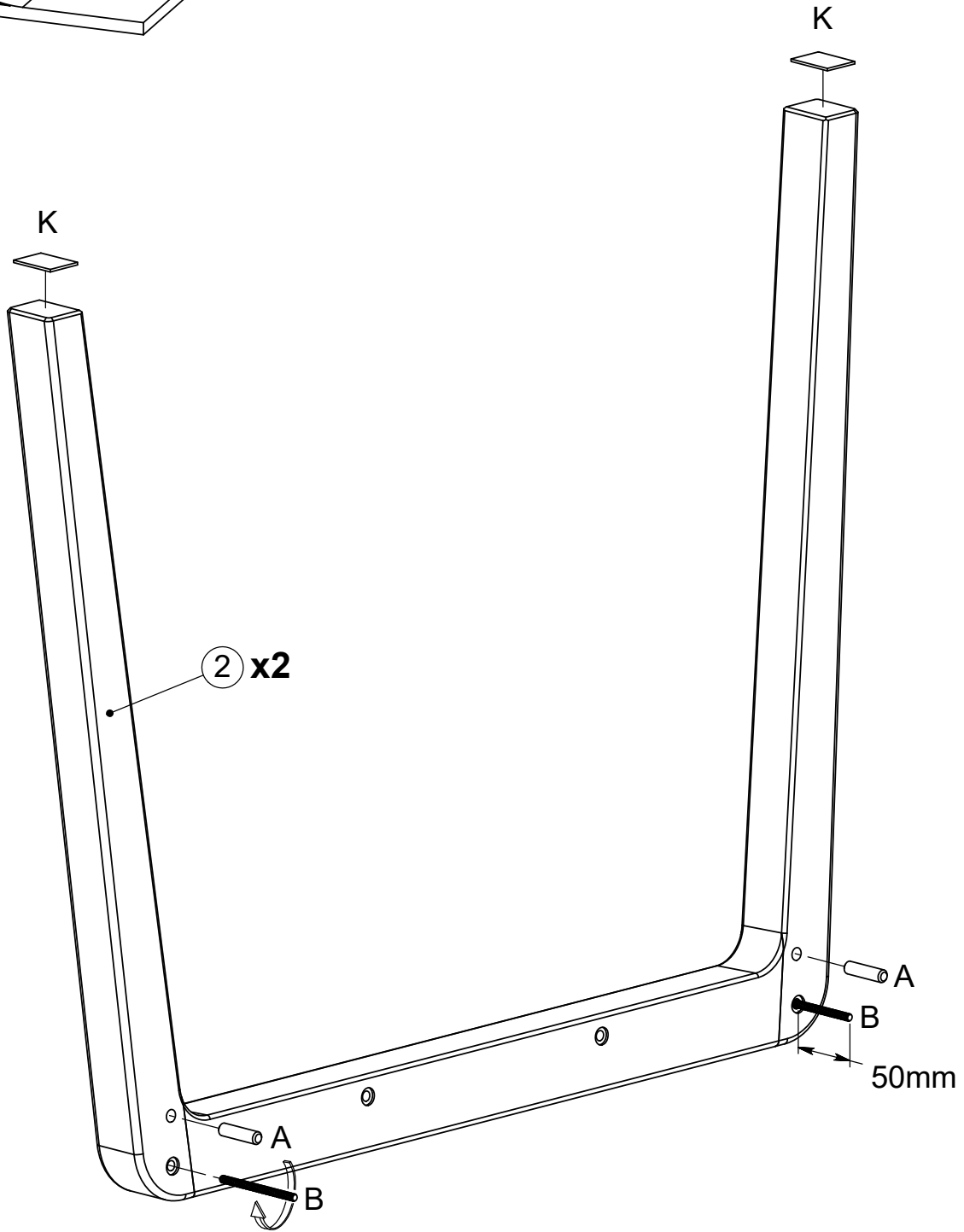
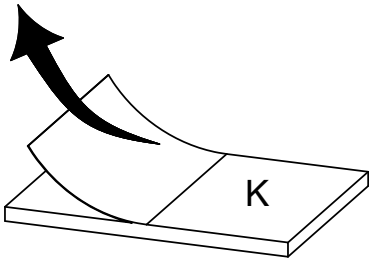
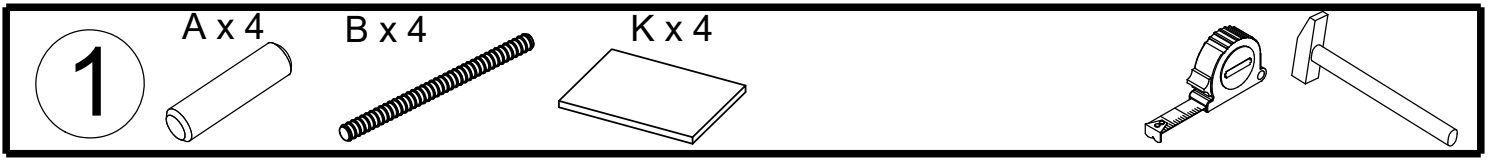

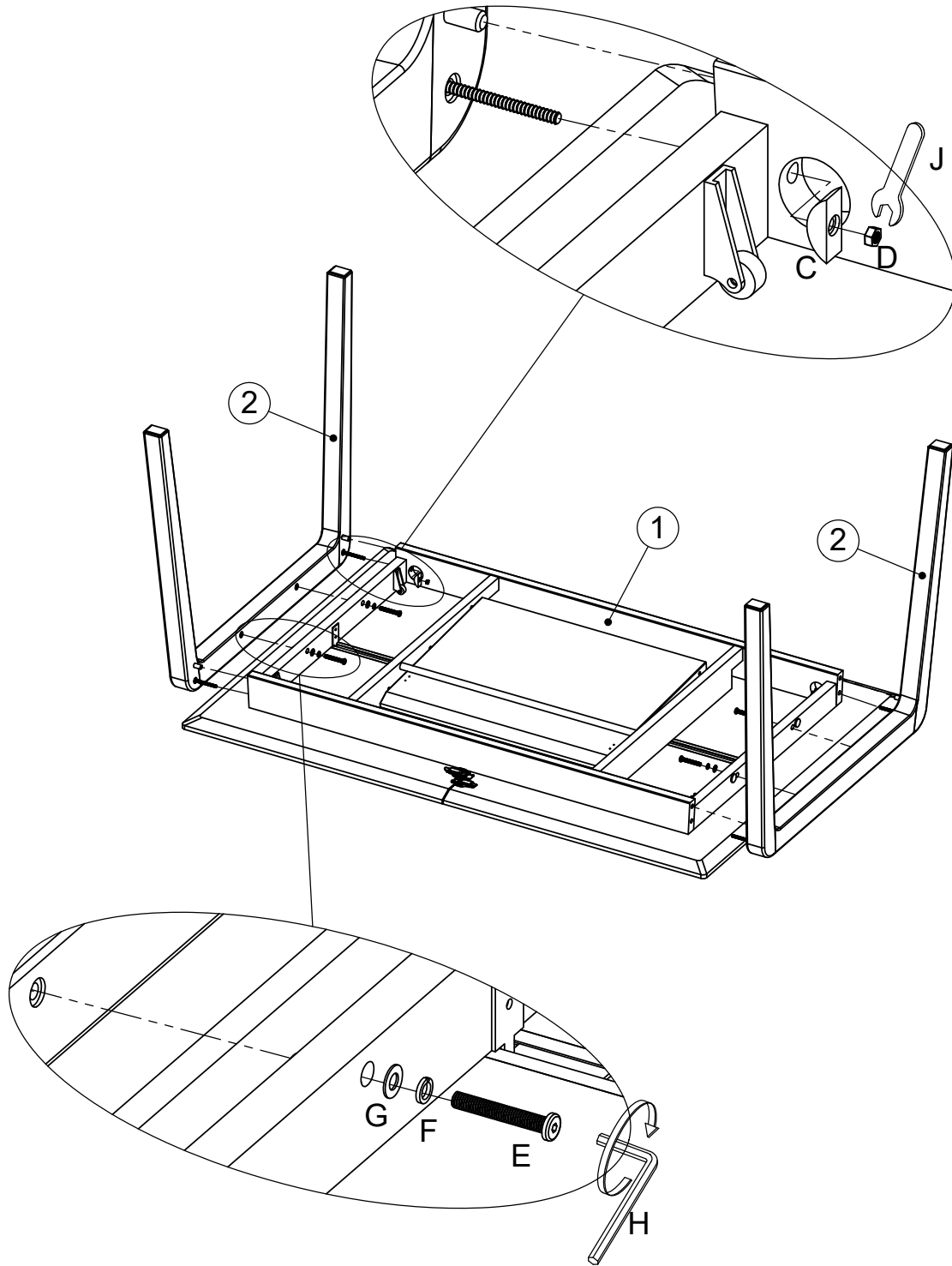
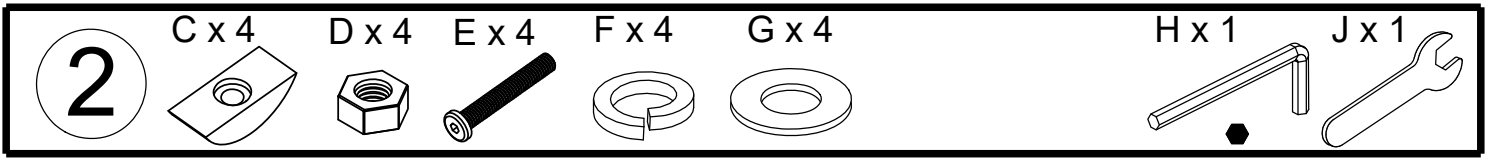

3

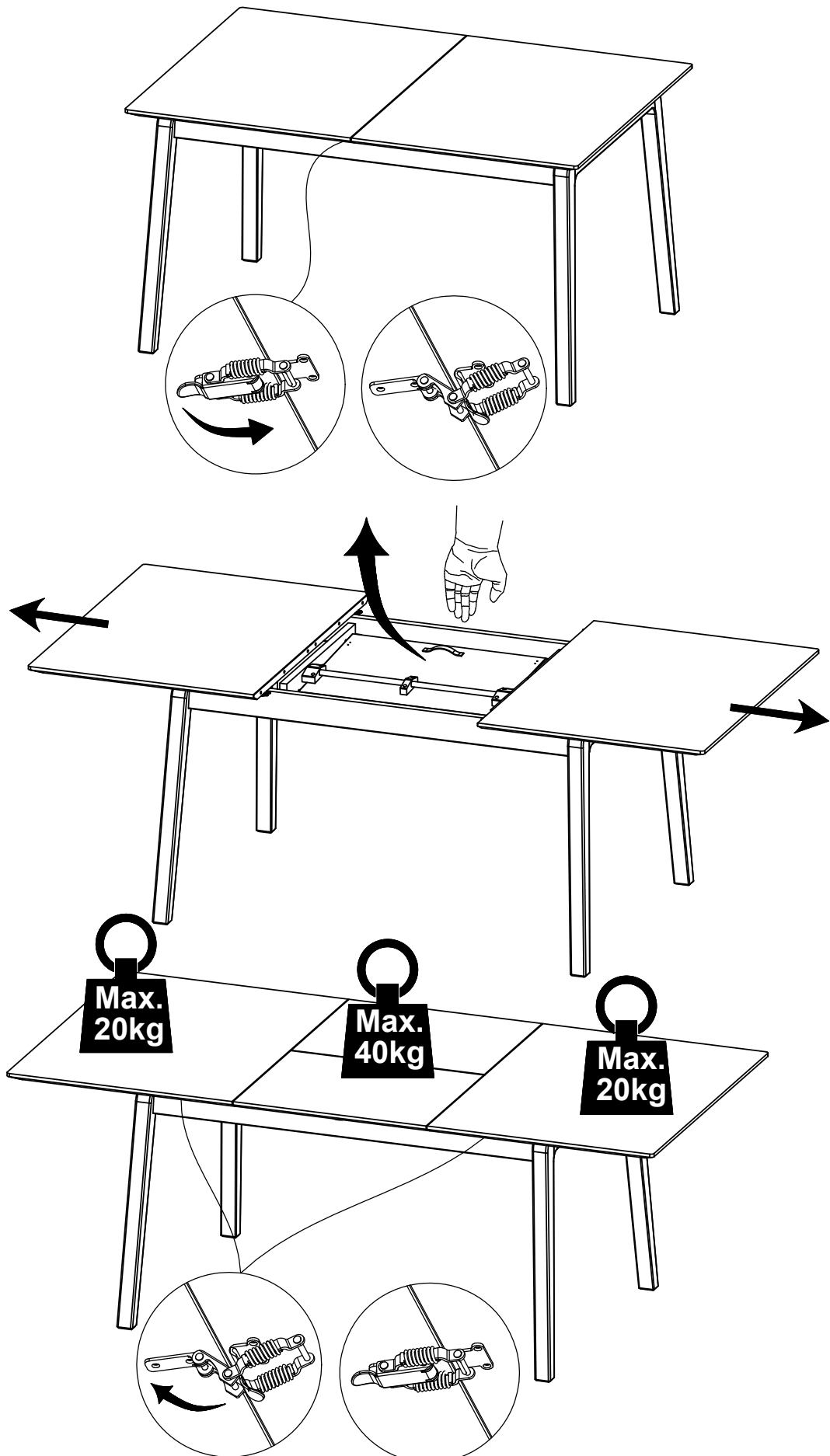



UK:

Always ensure the feet / felt pads provided with this product are suitable for your flooring.
Periodically check the position of any foot caps/felt pads used to ensure your floors are protected.

DE:

Wichtig : Bitte stellen Sie immer sicher , dass die mit diesem Produkt gelieferten FüÙe für Ihren Bodenbelag geeignet sind !
Bitte überprüfen Sie regelmäßig die Position der verwendeten Fußkappen oder Filzgleiter um sicherzustellen dass Ihre Böden geschützt sind !

ES:

Asegúrese siempre que los tapones de las patas de este producto son compatibles con su suelo.
Periódicamente revise que sus tapones y sus almohadillas de fieltro están correctamente colocadas para asegurar que su suelo esté protegido.

FR:

Assurez-vous toujours que les pieds/ patins fournis avec le produit sont compatibles avec le sol.
Contrôlez régulièrement la position des patins utilisés pour que vos sols soient protégés.

DK:

Sørg altid for at beskyttelse fødder / filt-puderne der følger med dette produkt, passer til Deres gulv.
Kontroller regelmæssigt placeringen at evt. beskyttelse fødder / filt-puder er korrekt placeret for bedste beskyttelse af gulvene.



UK:

It is important that any product which is assembled using any kind of screw is re-tightened 2 weeks after assembly, and once every 3 months - in order to assure stability through-out the lifespan of the product.

DE:

Es ist wichtig, bei jedem mit Schrauben montierten Produkt diese 2 Wochen nach dem Zusammenbau sowie einmal alle 3 Monate wieder anzuziehen, um die Stabilität des Produkts über die gesamte Lebensdauer hinweg zu gewährleisten.

ES:

En el caso de los productos ensamblados, es importante volver a apretar los tornillos 2 semanas después del montaje y después cada 3 meses, para así preservar la estabilidad durante toda la vida útil del producto.

FR:

Il est important que tout produit monté à l'aide de vis soit resserré 2 semaines après son montage, puis tous les 3 mois, afin de garantir sa stabilité durant tout son cycle de vie.

DK: VIGTIGT!

Det er vigtigt, at alle produkter, der samles med alle former for skruer, efterspændes to uger efter samling samt hver tredje måned for at sikre, at produktet er stabilt i hele dets levetid.