

NOVA LUCE

9088137

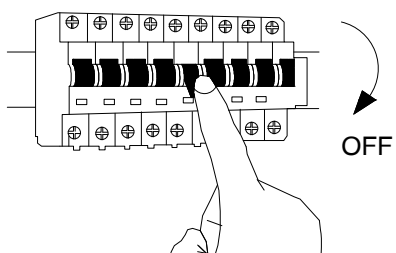

1. Turn off the general Switch

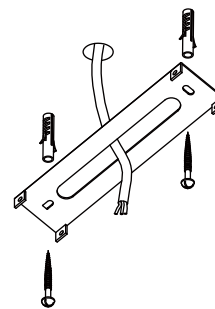

2. Align, mark and drill holes to apply the screws

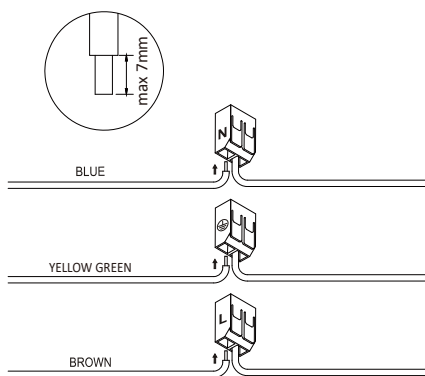

3. Connect the wires

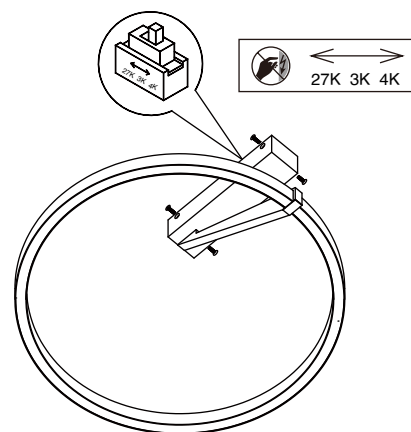

4. Apply the side screws

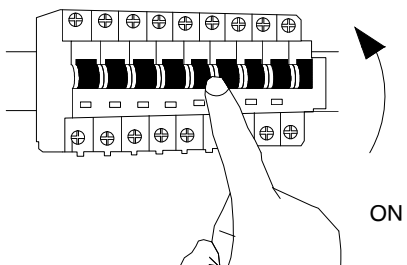

5. Turn on the general Switch

