

30 MIN

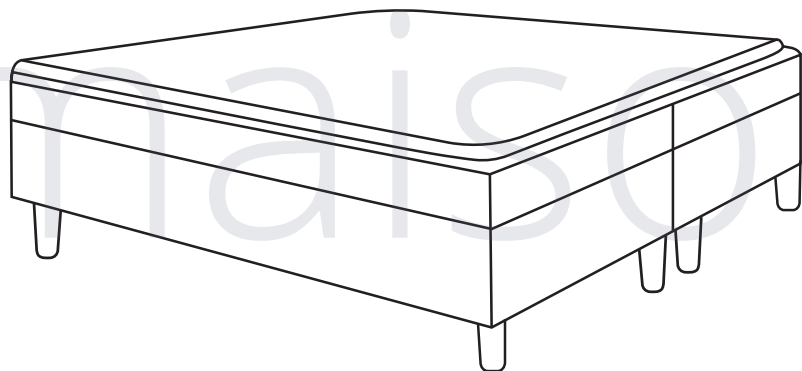

(PL) INSTRUKCJA MONTAŻU
 (CZ) MONTÁŽNÝ NÁVOD
 (D) MONTAGEANLEITUNG
 (TR) MONTAJ TALMATI
 (F) NOTICE DE MONTAGE
 (HU) SZERELÉSI ÚTMUTATÓ

(GB) ASSEMBLY INSTRUCTIONS
 (RU) ИНСТРУКЦИЯ ПО МОНТАЖУ
 (IT) ISTRUZIONI DI MONTAGGIO
 (SK) NÁVOD NA MONTÁŽ
 (RO) INSTRUCȚIUNI DE MONTAJ
 (NL) HANDLEIDING VOOR DE MONTAGE

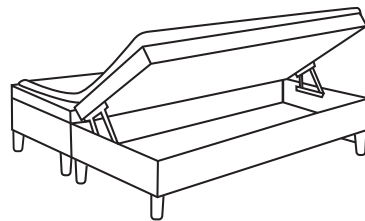

X 2

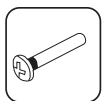

X 2

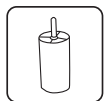

X 8

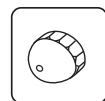

X 4

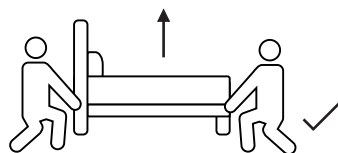
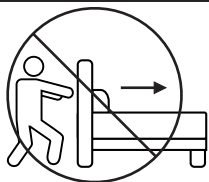

1



X 2

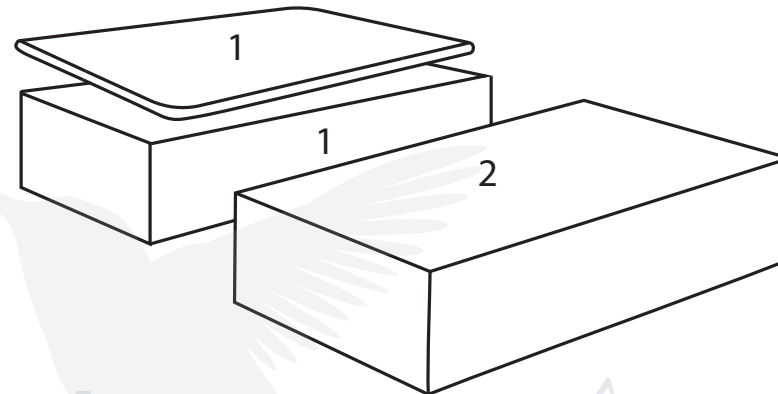

2



X 8

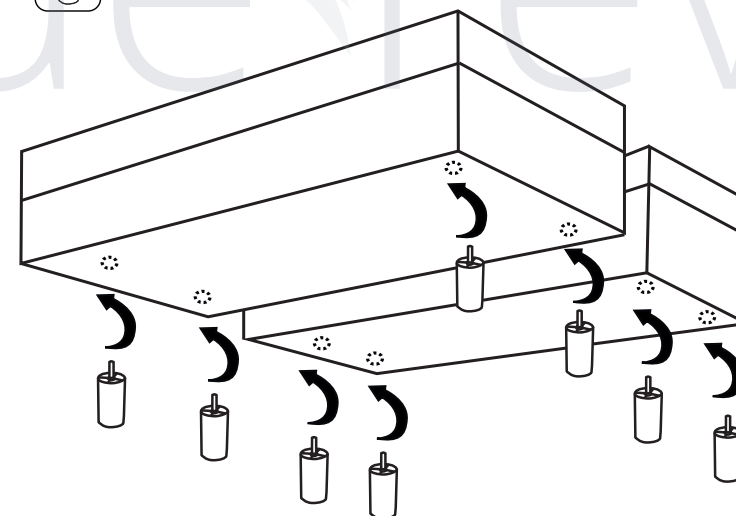

3

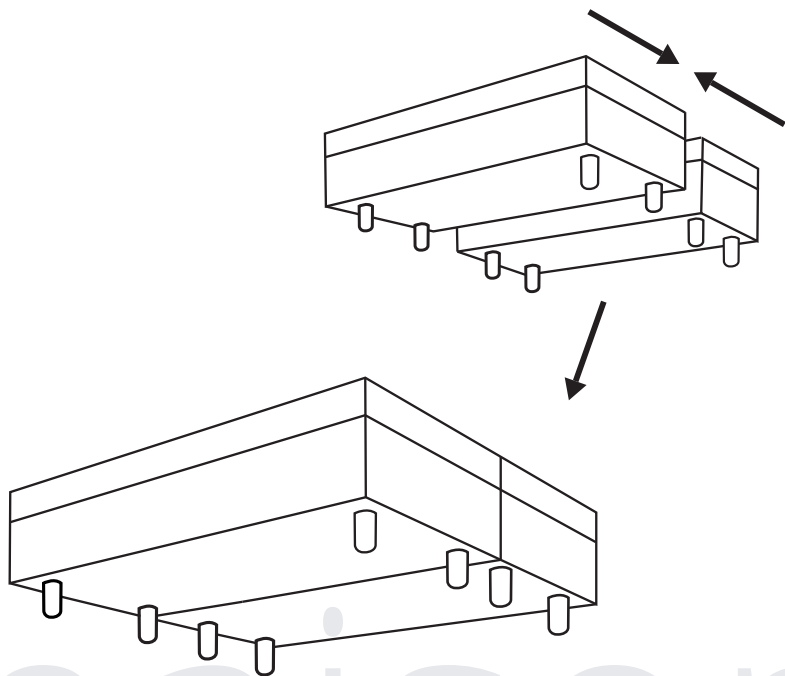

4

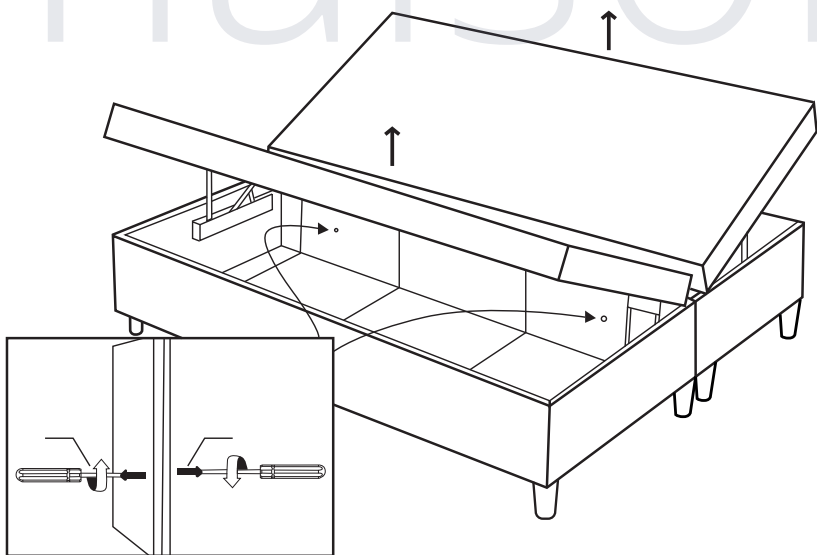

5

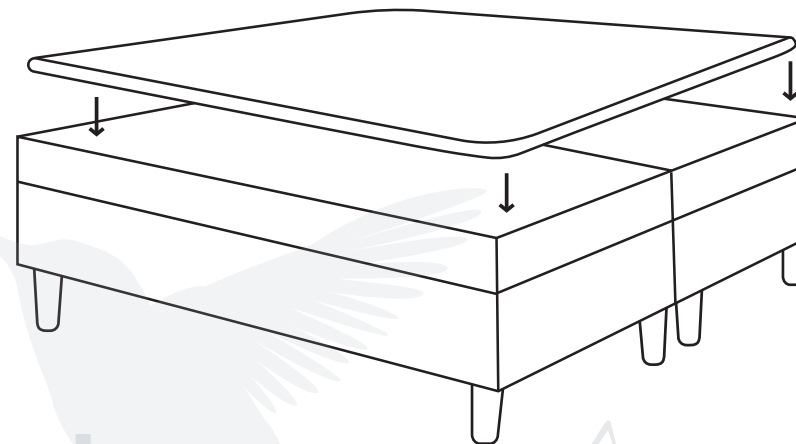

6

