







NO.	Design	Size	Qty	NO.	Design	Size	Qty
A		(M6×30cm)	4	B		(M6×30cm)	1
C		(M6×30cm)	1	D			1
E			1	F		Allen key (supplied)	1
G		Spanner (supplied)	1				

**FIG.**  
**1**





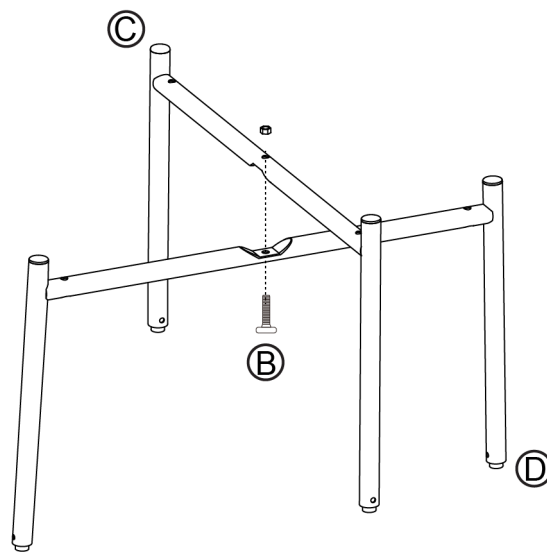
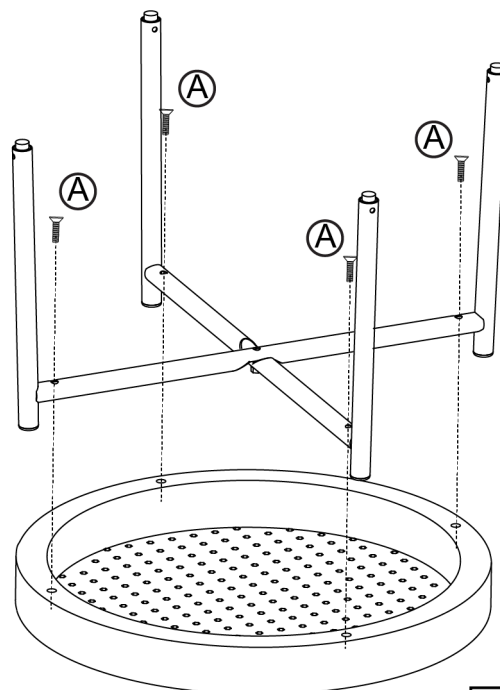



**FIG.**  
**2**



**01**

ASSEMBLY INSTRUCTION  
2111-TT-S186A-2292

NO.	Design	Size	Qty	NO.	Design	Size	Qty
A		(M6x30cm)	4	B		(M6x30cm)	1
C		(M6x30cm)	1	D			1
E			1	F			1
G		Spanner (supplied)	1				

**FIG.**  
**3**

