











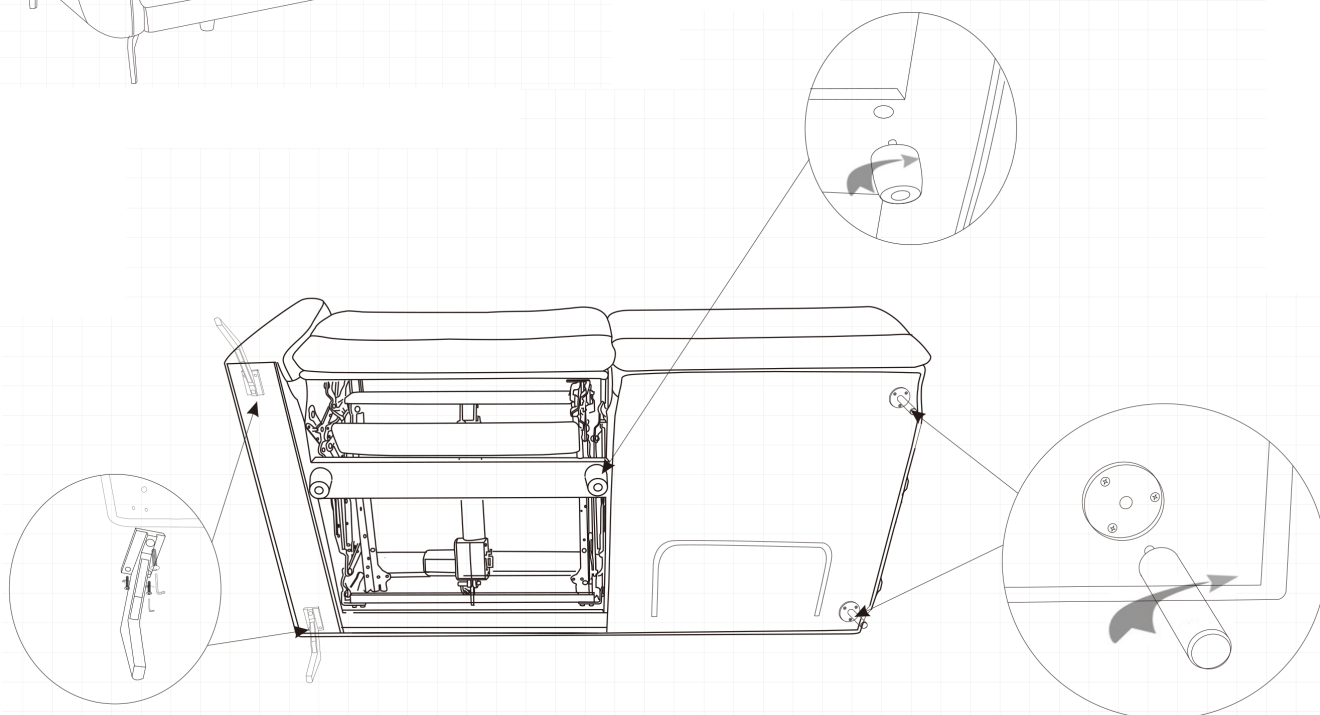
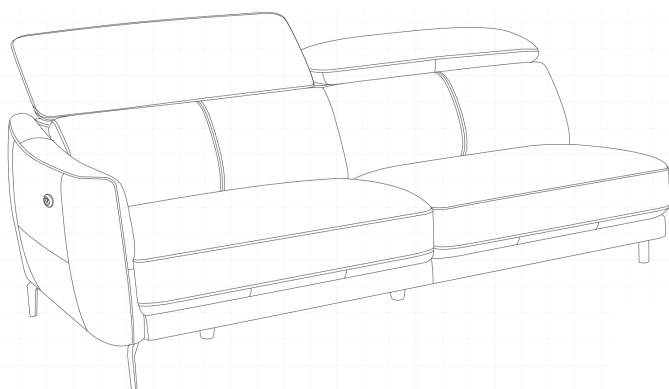

SETTING FITTINGS					
FITTINGS	SPEC.	AMOUNT	FITTINGS	SPEC.	AMOUNT
A		2 pcs	D		4 pcs
B		2 pcs	E		2 pcs
C		2 pcs	F		1 pcs

**FIG.**  
**1**



SETTING FITTINGS					
FITTINGS	SPEC.	AMOUNT	FITTINGS	SPEC.	AMOUNT
A		3 pcs	D		3 pcs
B		3 pcs	E		1 pcs
C		6 pcs			

**FIG.**  
**2**

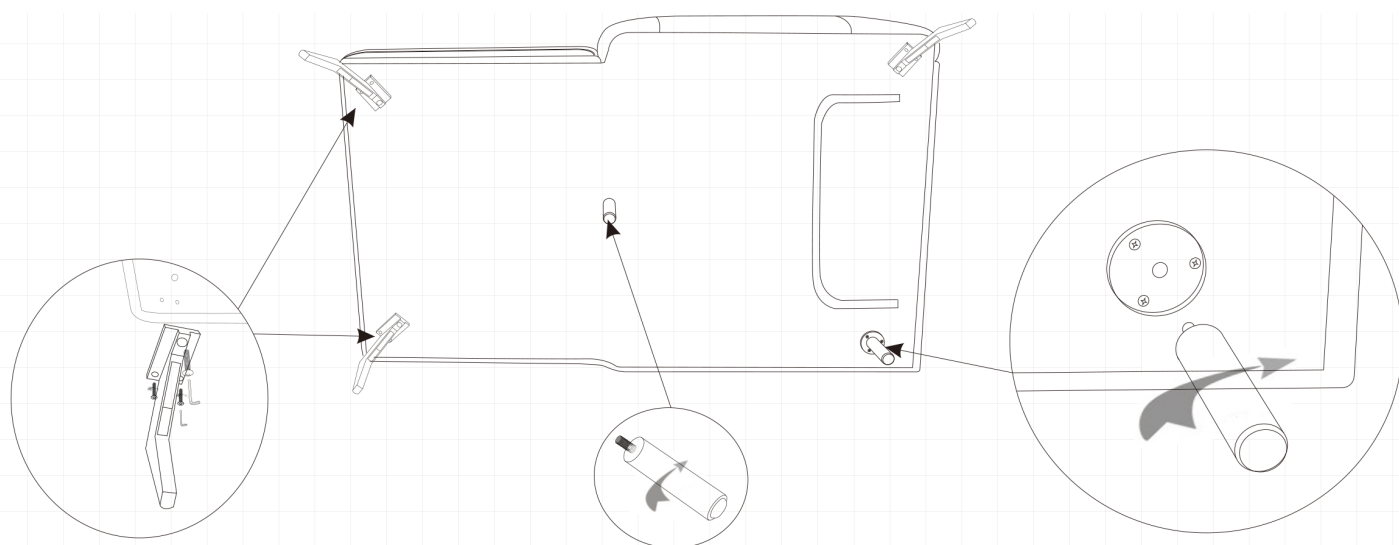
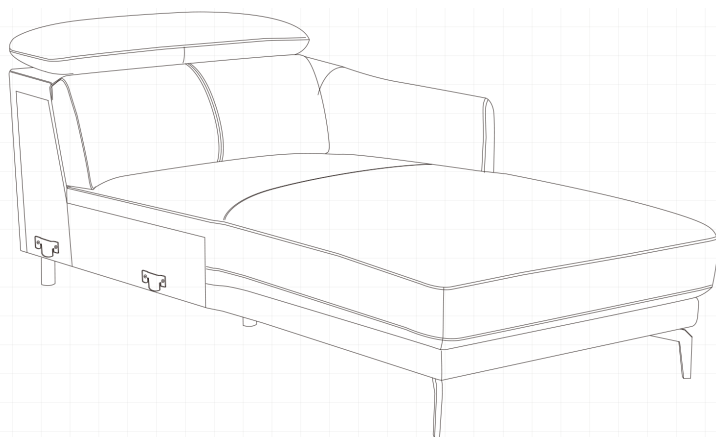

**FIG.**  
**3**

