

5112

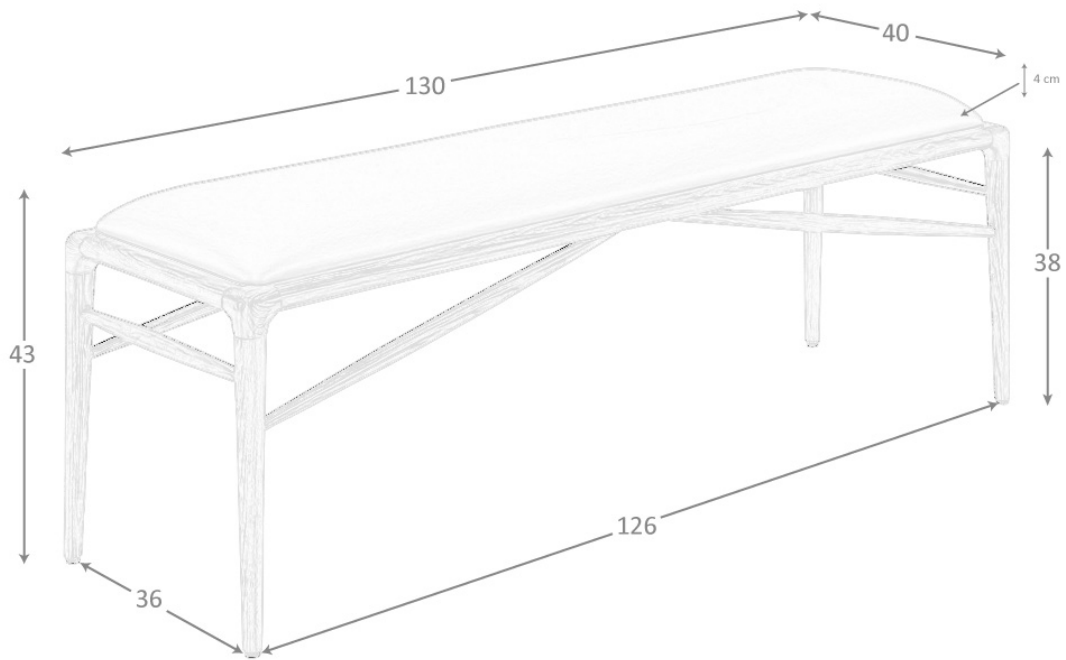

130 x 40 x 43 cm
23 Kg
0,31 m³

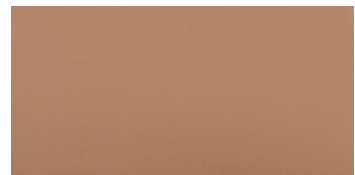

135 x 45 x 51 cm



25 Kg

